



# 1ST-LABS GROUP CO.,LTD

Incubation Investment  
Electronic R&D Engineering Service



# About 1ST-LABS

1ST-LABS



**Focus on Electronic R&D Engineering Service**

**Improve R&D and MP quality/efficiency**

**TÜV Certified  
Professional operation management**

**Focus electronic incubation investment  
supporting platform**

**More than 5000+ customers worldwide**

# Famous customers: 5000+ in wide field

1ST-LABS





# 1ST-LABS Quality System and Focus Filed

1ST-LABS



ISO13485

Medical

TÜV IATF16949

Automotive

TÜV ISO9001

Quality

TÜV ISO14001

Environmental



Medical Electronic



Automotive



Industrial Control

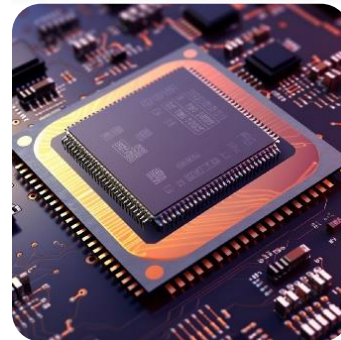

Semiconductor



## 1ST-LABS Technology Group

1ST-LABS



incubation & RD Service platform  
investment management

EECraftsman Technology



**Craftsman**

Products Design, Embedded system, PCB Layout, Products Optimize

Focus-Talents Consultant



**Focus-Talents**

Technical Experts  
Human Resources

KnowHow Technology Co.,Ltd



**KnowHow-Tech**

PCB, Components, Pilot Run/MP  
SMT/PCBA, Testing, BGA Rework,  
CNC, Tooling, Product  
Manufacture

IP-Plant Management



**IP-Plant**

IP Application & Management  
High-tech enterprise identification  
and innovation fund consultant

# 1ST-LABS operation location

1ST-LABS



R&D Center



Operation  
Headquarter



MP  
Factory

# 创馨科技1ST-LABS 电子研发工程服务

1ST-LABS



Product define | Product research & development | Product mass production | Product delivery and maintenance



R&D Cycle Phase

MP, go to market, after-sales maintenance

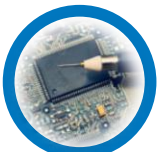

Hardware Schematic Design



Embedded Software

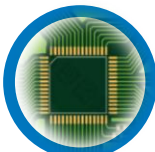

PCB Layout



PCB Production



Component Purchasing



R&D SMT Pilot Run



Quality Control



DFT/DFM



PCBA Mass Production



Testing Assembly



Packaging Logistics



Product Development



Encryption Protection

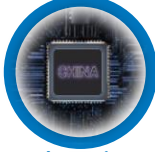

Alternative Design



BGA Reballing



BGA Fly wire



BGA Rework



3D Printing



Aftersales Repair Service



Component Analysis

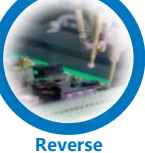

Reverse Engineering



R&D Tools

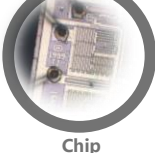

Chip Decap



Entrepreneurship Resource Management



Technical Expert Service



CNC Machining



IP Consultant



High-tech Enterprise Application consultant

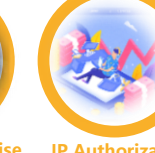

IP Authorization Management





[More Details](#)

# 1ST-LABS Quality Control

1ST-LABS



## R&D process management

Schematic design  
Wrapper library specification  
PCB layout and wiring

01

STEP

## Material quality control

PCB processing  
Component procurement  
Production consumables procurement



02

STEP



Quality Control

STEP

04

## Production-manufacturing

Production process management  
SOP and process control  
Functional and performance testing



STEP

03

## DFT/DFM

Design for testability  
Design for manufacturability  
System process optimization



Participate in R&D, and get involved in process of optimizing in advance

Control the whole process from parts to production process

Participate in designated ICT and FCT test programs

TÜV management system, excellent yield rate

Provide high quality delivery at low total cost

# EECraftsman – Hardware Schematic Design

1ST-LABS



## MCU/ARM

Adopt leading ultra-low power architecture chip in this industry to achieve more robust and efficient interconnection, and develop products in industrial products, cloud connectivity, artificial intelligence and other fields to provide complete solutions.



## FPGA

Provide one-stop services such as FPGA logic design, FPGA related circuit development, embedded system design, high frequency and high speed board, prototype or template and mass commissioned production.



## HCI

Provide a wealth of human-computer interaction hardware and software design solutions, including resistance screen, capacitive screen, touch control, human-machine control interface, information feedback, actuator, etc.



## DC/DC Power

Railway, traffic, harsh environment industrial control, ultra-low noise sampling system power supply, low noise and of medical equipment power supply product design, commissioning, certification, mass production one-stop service.

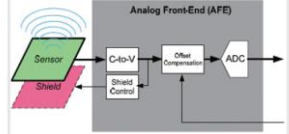

## AFE

We have a wealth of sensor signal acquisition, small signal processing, low noise amplifier circuit, low delay, high precision reference source, high precision ADC sampling circuit R & D, design, manufacturing experience.

# EECraftsman – Embedded Software development

1ST-LABS



Embedded C

Verilog

Linux

FreeRTOS

QT

Programming Platform

PID

Motor Drive

Encoder

Motion Control

HMI

Algorithm Development

# EECraftsman – PCB Layout

1ST-LABS

cādence

**Altium**  
Designer.

Familiar with the essence of  
DFT and DFM

Standard Design Lib  
management system

Verify optimization in real  
time on the production line

Exquisite Craftsmanship  
Design Spirit



# EECraftsman – PCB Layout

1ST-LABS

- 26+ layers of communication board
- F P G A
- C P L D
- D D R 4
- Low voltage and high current power supply

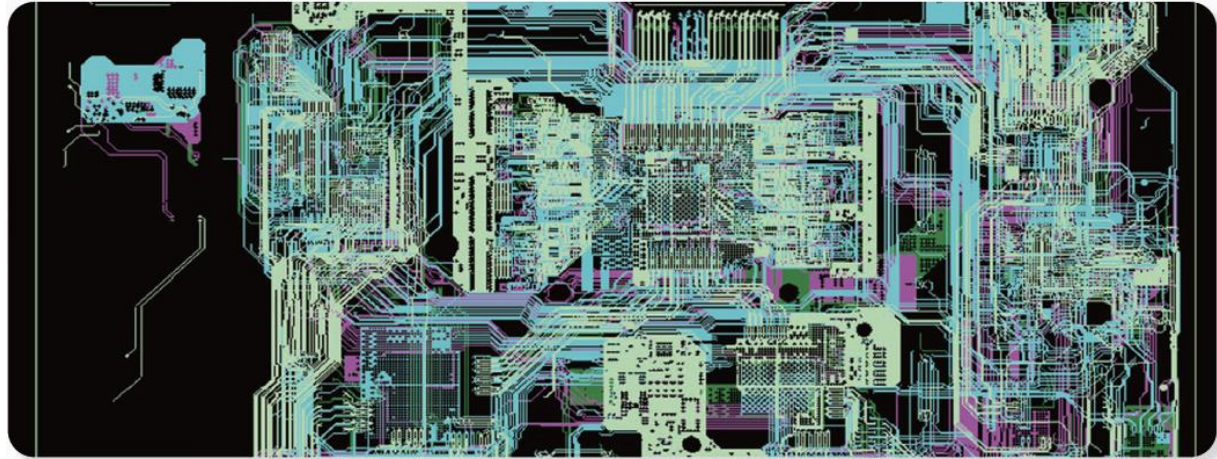

- HDI
- 8 layers of buried blind via
- Laser drilling
- High precision

0.33oz	1/3 O.Z.	1.1mil
0.33oz	106 (76%)	2.05mil
0.33oz	1/3 O.Z.	0.9mil
0.33oz	106 (76%)	2mil
0.33oz	1/3 O.Z.	1mil
0.33oz	106 (76%)	2.1633mil
0.5oz	0.19mm(0.16mm) HH	7.4mil (6.1)
0.5oz	106 (76%)	2.1633mil
0.33oz	1/3 O.Z.	1mil
0.33oz	106 (76%)	2mil
0.33oz	1/3 O.Z.	0.9mil
0.33oz	106 (76%)	2.05mil

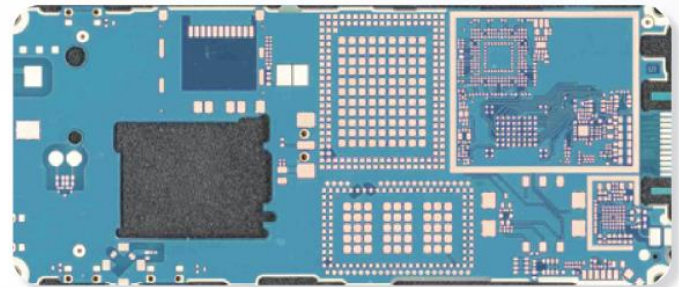



**Medical  
Electronic**

- Precision stepping control system
- High performance, low noise LED light source
- Wireless data transmission within the organism
- Ultra-low power analog front end
- Software and hardware technologies such as sampling processing and algorithm optimization
- Wearable medical devices
- Ultra-miniaturization design and production



**Intelligent Vehicle  
Transportation**

- Component selection and redundancy design
- Stability and reliability design
- Three defense and reinforcement
- Hardware and software redundancy
- PCB EMI optimization processing
- Encryption and security
- Systematic integration and fool-proofing structure

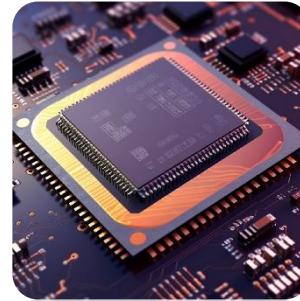

**Semiconductor  
Chip**

- Wafer Scribing, fast package
- Bare die test board design
- Packaged test board design
- Test system PCBA
- DEMO board design
- Application development support
- Module design and batch delivery



**Industrial  
Control**

- Sensor optimization
- Wired transmission interface
- Wireless transmission interface
- Motor drive
- HCI interface
- Edge computing node
- Reliability and stability
- Tough environment prevention treatment
- CCC, UL, CE certification services

# EECraftsman – SHA256 Encryption Solution

1ST-LABS

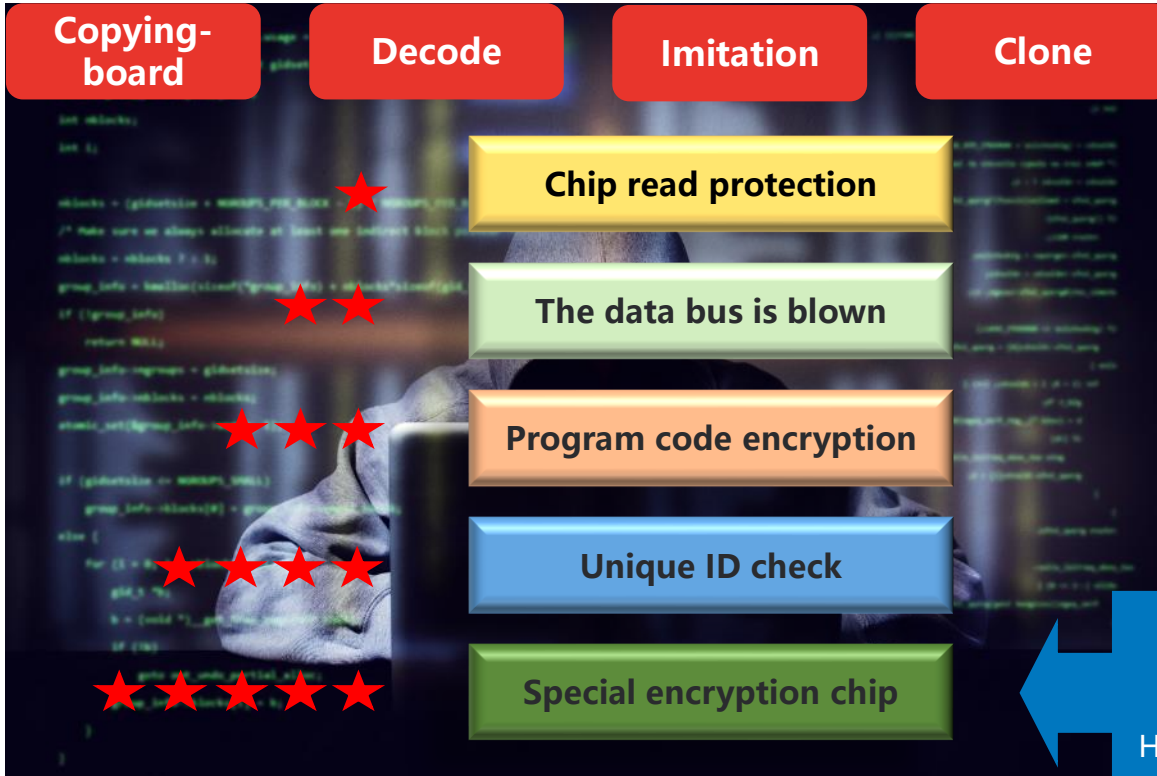

It is theoretically impossible to crack at present.

EECraftsman  
Developed based on SHA256  
Encryption Solution  
Hardware chip + Algorithm library



# EECraftsman – SHA256 Encryption Solution

1ST-LABS

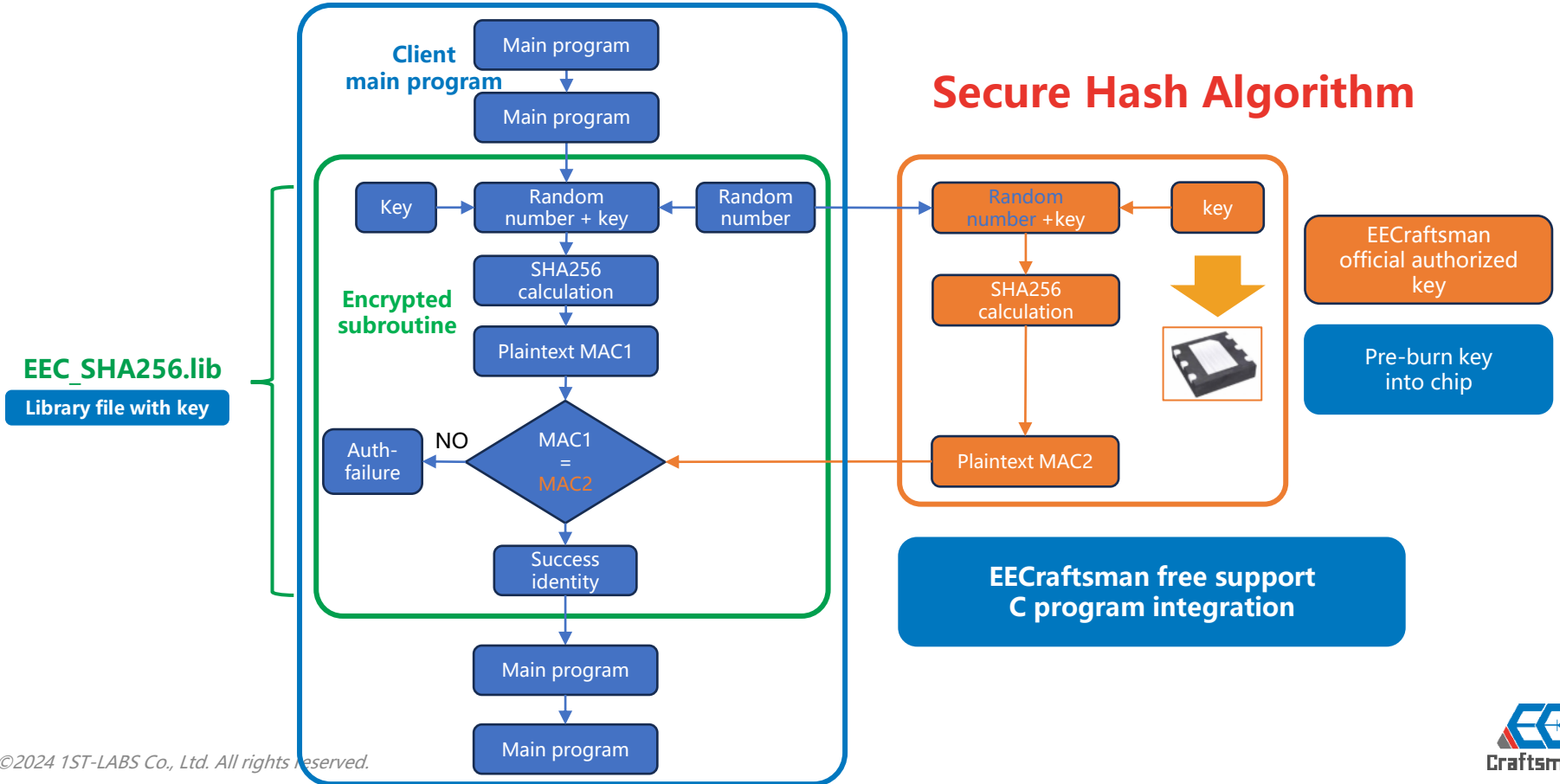

# EECraftsman – Domestic Alternative Design

1ST-LABS



Reduce the overall product cost

Solve the shortage of material supply

Analog circuit domestic substitution

Digital circuit domestic substitution

Performance testing and verification

Domestic MCU code transplantation

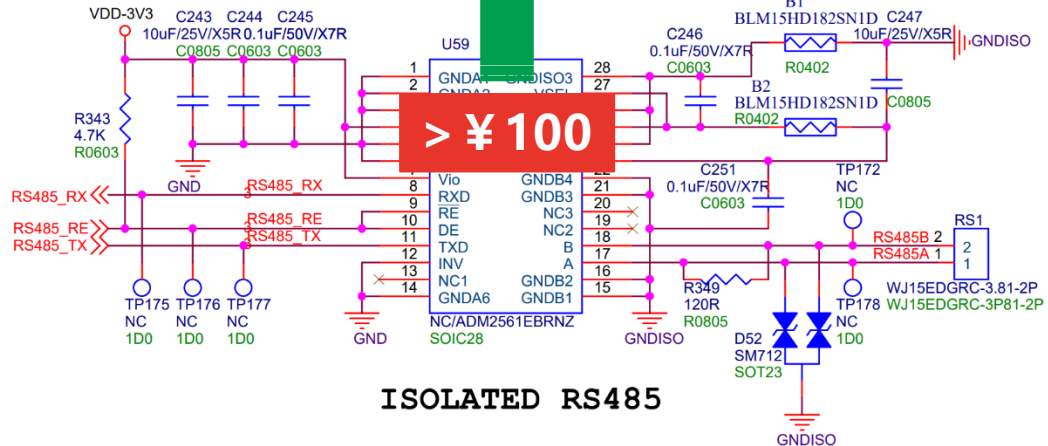
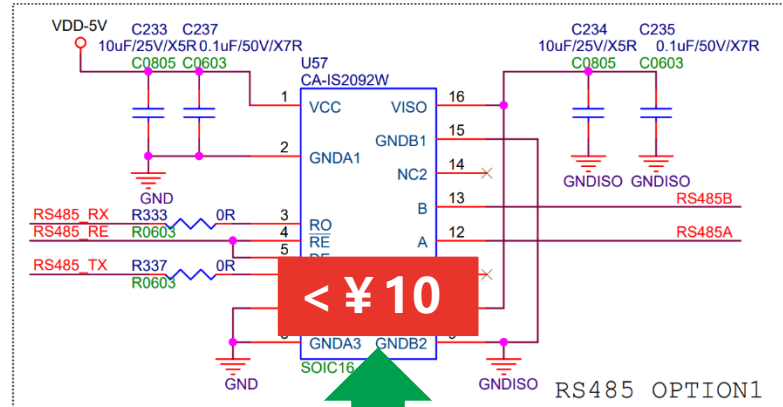

ISOLATED RS485

# EECraftsman – Component Analysis

1ST-LABS

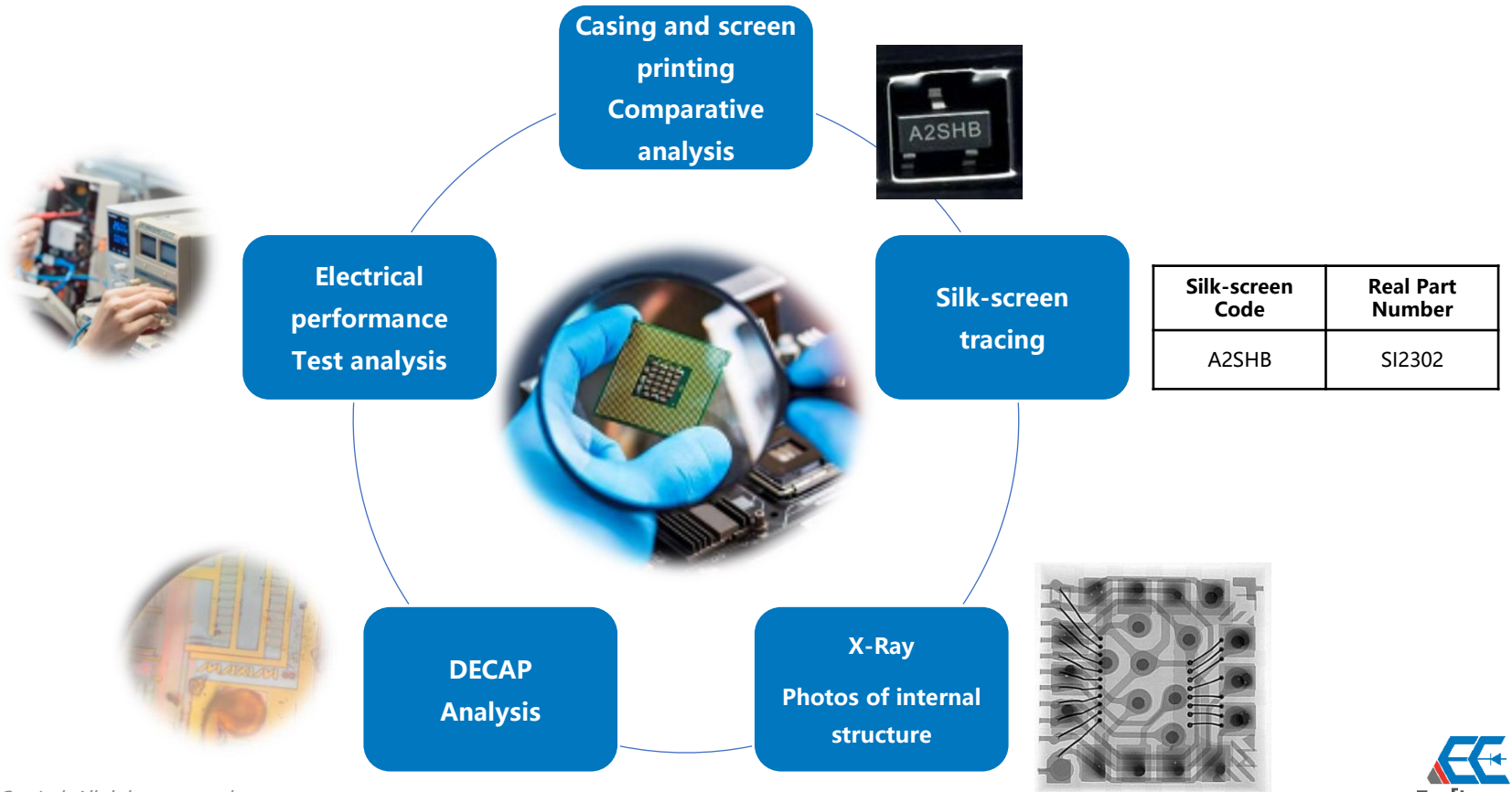

# EECraftsman – Digital Reverse Analysis

1ST-LABS

Fine mechanical grinding  
Laser scanning  
Digital modeling



Build the library of schematics  
Network reconstruction  
Schematic backtracking

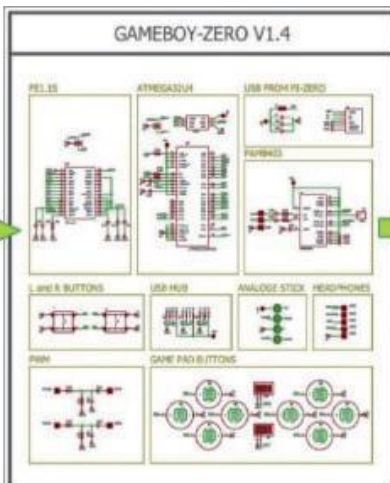

Rebuild Gerber  
Reconstructed network table  
Measuring component parameter



Chip silk-screen tracing  
Chip DECAP analysis  
Chip code read

**Customers are required to declare legal compliance with reverse analysis products  
EECraftsman does not assume any legal risk or liability**

## R&D RC Sample Kit



### Resistor Series

0201

0402

0603

0805

1206

1% 128 Value (Single box) 0Ω-1M

5% 170 Value (2 boxes) 0Ω-10M

1% 484 Value All Series (4 boxes) 0Ω-10MΩ

### Capacitor Series

0201 52 Value 0.5pf-0.22μf

0402 68 Value 0.5pf-2.2μf

0603 73 Value 0.5pf-10μf

0805 66 Value 1pf-22μf

NR-2501



NR-2308



signal test point



Taobao Store

Genuine Article

Complete Category

Spot Stocks

# Focus-Talents – Entrepreneurship Resource Management

1ST-LABS



**Incubation Resource  
Management Services**

**Human resource trusteeship**

**Data center construction**

**Human resource ability assessment**

**Industrial policy and park policy**

**Legal and arbitration dispute  
handling support**

**Enterprise management system  
consulting services**

## TECHNOLOGY EXPERT



**Expert Advisory Services  
on Key Technologies**

Low noise power supply

High precision ADC sampling

Low voltage high current DC/DC

EMI & EMC

Low power design for handheld devices

Failure analysis

Other expertise

# 1ST-LABS PCB Production

1ST-LABS

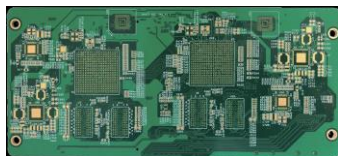

## PCB manufacturing management expert

Field visits to certified partner factories

Factory scale

Precision of equipment

Quality system

Delivery speed

Technological level

Industry reputation

Determine matching plant according to design

Professional DFM process adjustment

Deal with PCB EQ

VIP customer cost control

Quality first fast delivery

Process Analysis



Quality Control



Delivery Management

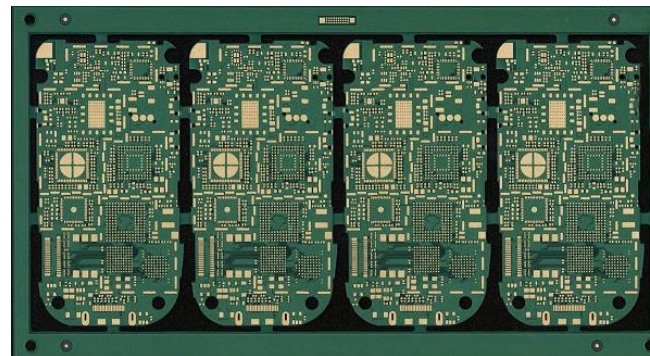

Up to 46 boards

High TG board

3mil Line width  
Line distance

30:1 aspect ratio

HDI Blind buried hole

Rigid and flexible version

Up to 60Z copper thick

Max. 7mm plate thickness

Rogers high frequency plate

aluminum substrate

FPC board

impedance matching



# 1ST-LABS Component Purchasing

1ST-LABS

Conventional components,  
spot stock

Authorised  
Chanlel

4000+

Spot Stocks



Consignment  
centralized  
purchasing



Small batch/sample  
distributor channel

High Volume agent  
channel



# KnowHow-Tech – R&D SMT Polit Run

1ST-LABS

A nut can also be cracked  
by a sledgehammer.

Intelligent flexible  
manufacturing technology

Standardized Quality  
Management System



Focus on Fast  
SMT Pilot Run



One-piece welding  
No minimum  
consumption



Advanced  
technology  
Professional quality



Fast delivery in 72 hours  
Fast-Pass in 24 hours



ISO13485

TÜV ISO9001

TÜV ISO14001

TÜV IATF16949

Stencil-free paste technology  
Intelligent adjustment of the  
thickness/area/size of tin spray



X-Ray Fast  
Point  
component



MYCRONIC  
MY700 Solder  
paste printing



Samsung 481  
patch machine  
Feeder switch



Samsung 482  
patch machine  
Feeder switch



ERSA14 Nitrogen reflow  
welding is supported in the  
warm zone

# KnowHow-Tech – R&D BGA Rework & Fly Line

1ST-LABS

Fast repairment in 24 hours

IPC Certified maintenance technician

Remedy design errors

Shorten debugging time

Reduce R&D costs

Improve R&D efficiency

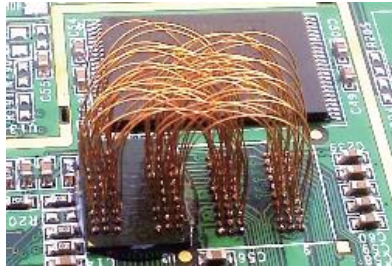

BGA Fly Line

BGA Inside flight , BGA leads outward

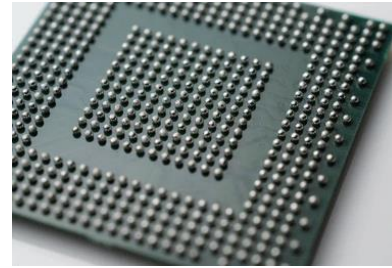

BGA Unsolder, reballing, rework

BGA, LGA, CSP, WCSP



DC rework workstation

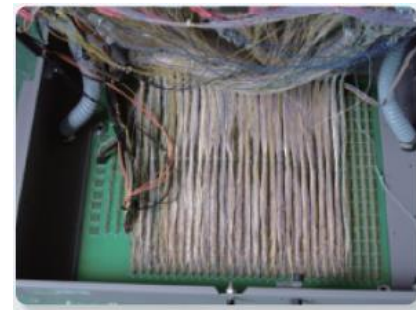
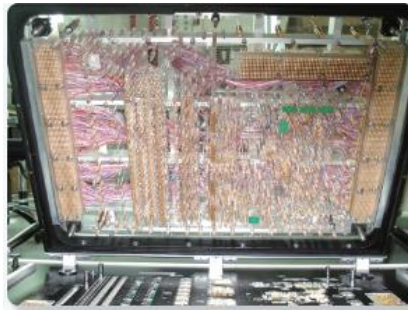

Case: IC test system, 28-layer PCB, thousands of lines, important core Socket non-destructive repair



## Chip Part-Number Analysis

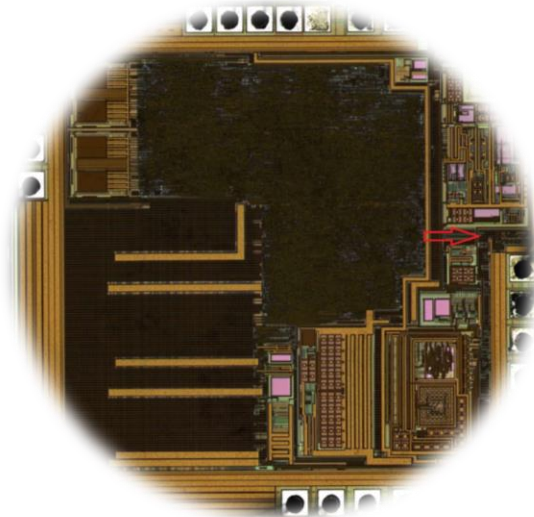
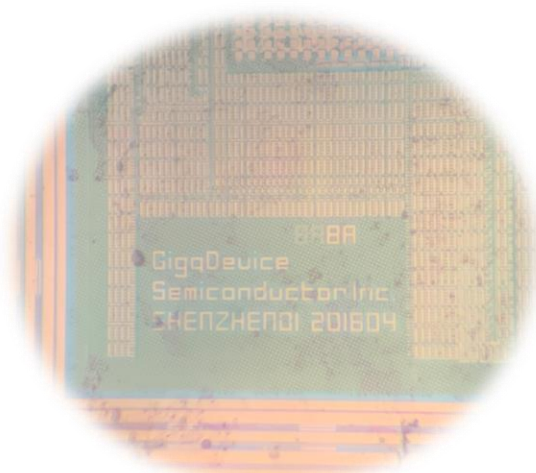
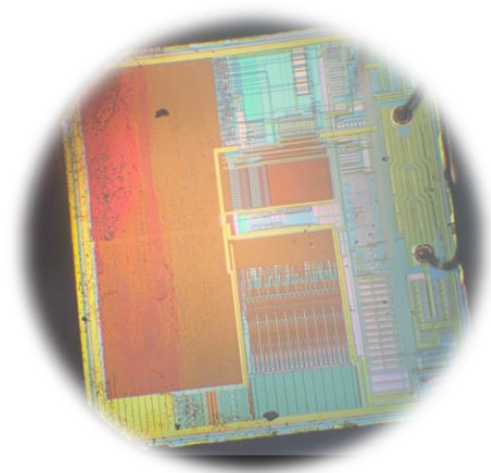

# KnowHow-Tech – 3D Printing & CNC Machining

1ST-LABS



## R&D 3D Printing & small-lot CNC

3D printer/Professional CNC Machining center (30 sets)



3D structure printing, size error  $\pm 0.1\text{mm}$



CNC precision machining center, size error  $\pm 0.02\text{mm}$



## Mass production DFT/DFM optimization

Professional services from R&D to mass production

Manufacturability

Assembling ability

Yield of mass production

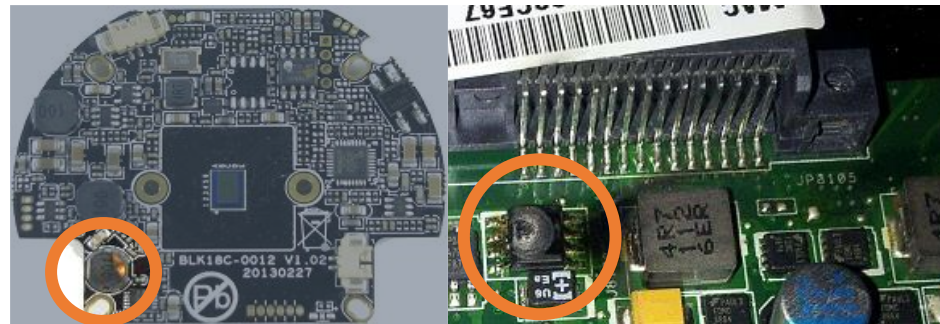

Failure analysis, ESD optimization, stress release optimization

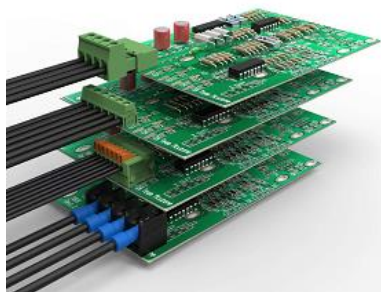

Assembly reliability optimization

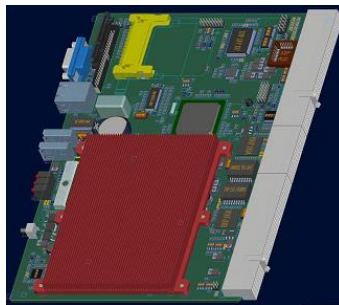

Structural process optimization

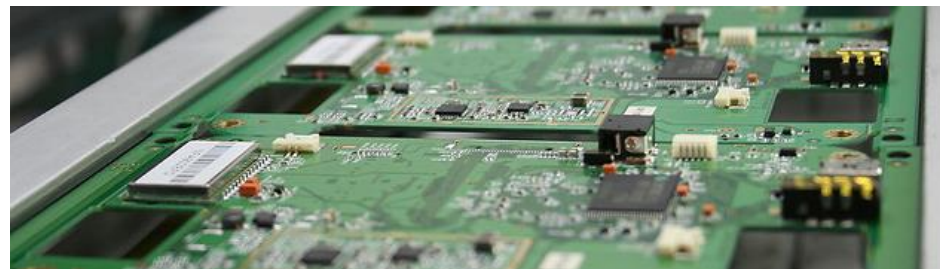

Batch production process DFT/DFM optimization, through rate and yield optimization

# KnowHow-Tech – PCBA Mass Production

1ST-LABS



Standardized batch manufacturing



TÜV ISO14001

TÜV ISO9001

Standardized Quality Management System

TÜV IATF16949

ISO13485



X-Ray Point component



GKG solder paste printer



Solder paste printing local optimization



SPI Solder paste detection



JUKI chip mounter



JT 12+3 zone nitrogen double track reflow welding



AOI AOI Detection



Wave-soldering

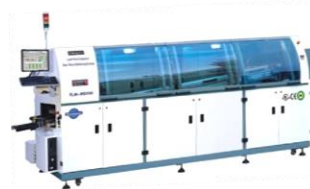

First piece detector



X-Ray analysis

Daily full load mounting capacity of 1 million components

# KnowHow-Tech – Testing & Assembly

1ST-LABS

## Product Manufacturing

Standardized Quality Management System



TÜV ISO14001

TÜV ISO9001

TÜV IATF16949

ISO13485



Test fixture, fixture design and processing

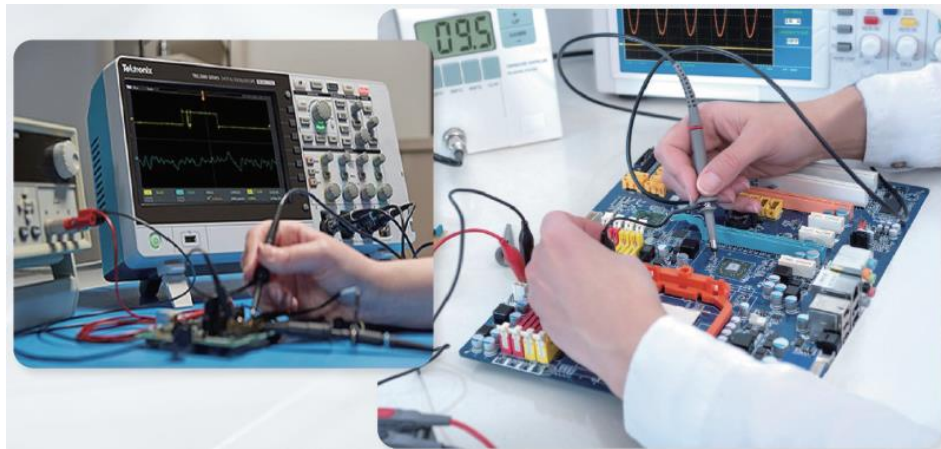

Performance Test



Product Assembly



# KnowHow-Tech – Packaging & Logistics

1ST-LABS

Small and micro enterprises one-stop product package service

Packaging customization, warehousing management, logistics assistance



Batch board transfer framework, buffer material and packaging customization



5226 0112 7758 2334 250

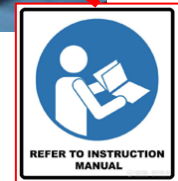

# KnowHow-Tech – Aftersales Repair Service

1ST-LABS



Fault Analysis

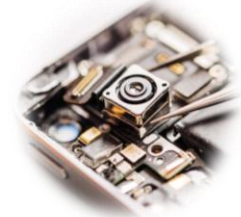
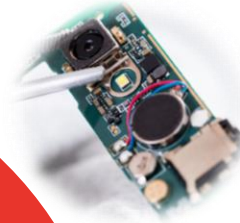

Comparison of Schematic

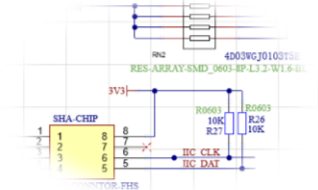

Batch Rework

IPC Certified  
maintenance technician

Chip level  
repair



BGA Rework

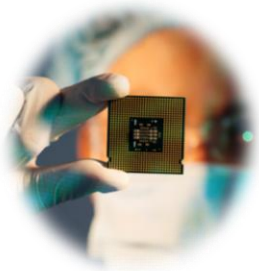

# IP Plant - Intellectual Property Consultant

1ST-LABS

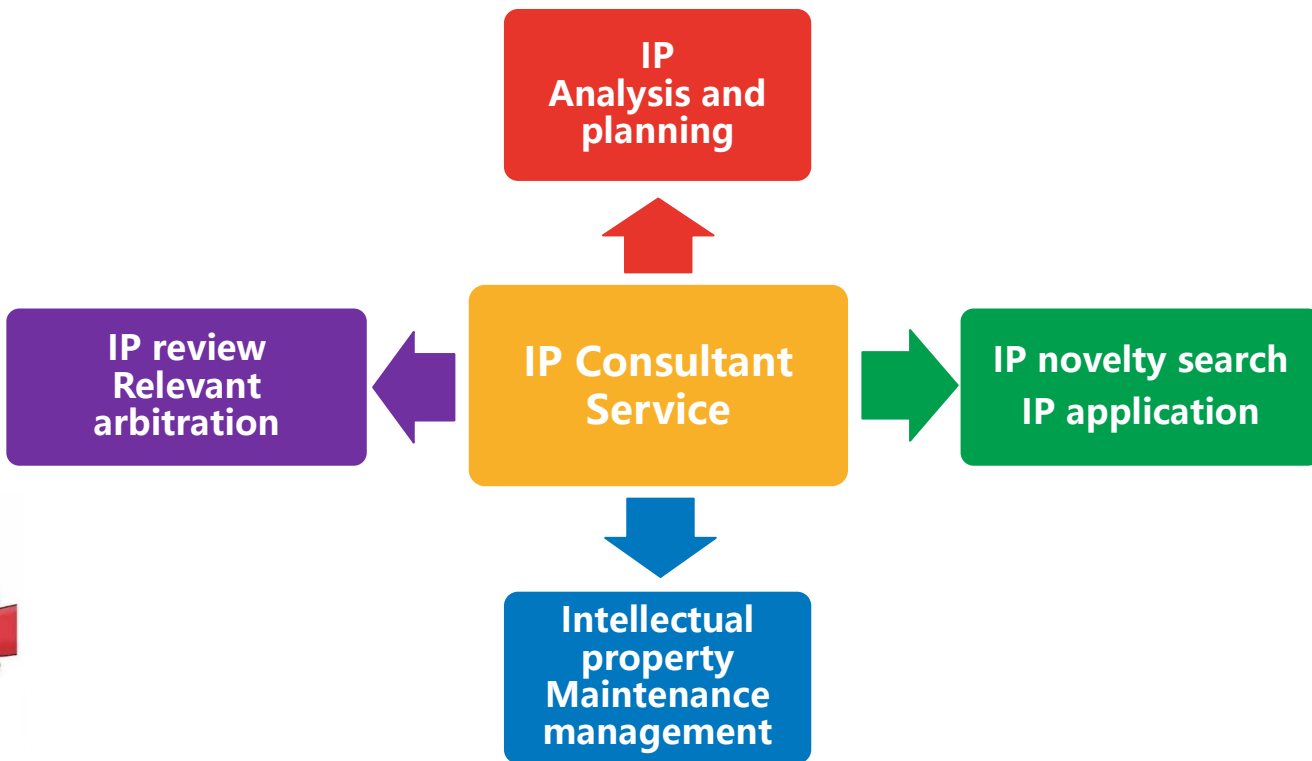

# IP Plant - High-tech Enterprise Application consultant

1ST-LABS



## Policy real-time interpretation

- Focus on real-time information
- Update policy interpretation

## Intellectual property planning

- Patent mining and application
- Innovation management and planning

## Declare qualification

- Guide the preparation of relevant materials
- Material compliance check

## One-stop service

- Long-term development plan
- Full process consulting services

6-28 months IP application management » Apply for planning, apply for counseling, consulting services » Project increment

Registered Trademark

Appearance patent

Application for innovation fund

From 200,000

Promotion of Brand

Trademark design

Utility model patent

Application for high-tech enterprises

High-tech subsidies from 50,000

Tax Relief

Copyright

Patent for invention

Little Giant from 600,000

Financial Credit

Software copyright

Integrated circuit layout

# IP Plant - IP Authorization Management

1ST-LABS



REFUND



CASH



CREDIT



BANK



SAVINGS



SIGNATURE



GOLD



INVESTMENT



VALUE



01

Value Planning

R&D phase  
intervention planning  
Apply for agency

02

Timesaver

Industry target customer  
database  
Accurate matching,  
efficient and time-saving

03

Value return

Professional analysis  
and valuation  
Value maximization

04

Professional  
management

Professional legal team  
Professional management  
team

Intellectual Property authorised management  
consulting services

Intellectual Property trading  
consulting services

1ST-LABS



Thanks !

创馨科技集团： 创业孵化及电子研发工程服务

[www.1st-labs.com](http://www.1st-labs.com)